

KAKOU



KAKOU USA, LLC

Address: 4901 Enka Hwy. Morristown TN 37814

Phone: (423) 585-7382

Web: www.KAKOUUSA.com

(Machining, Fabrication, Equipment build)

“COMMITMENT TO EXCELLENCE”

SERVICES WE OFFER:

- Control cabinet building
- Fabrication
- Machining
- Tool and Die
- Machine building
- Repair/service on machine
- Capability study
- Other

KAKOU USA, LLC

At KAKOU USA, LLC we strive for "committing to excellence". Our company specializes in machine design/building, and we also offer machining and fabrication services. Every day we search for new and innovative ways to help our customers get their product as quickly as possible while still adhering to our strict quality control standards. Our regular customers particularly value our quick response and our quality.

ABOUT US:

KAKOU USA, LLC is a small privately owned minority business committed to providing our customers with the utmost excellence by delivering quality products and dependable service.

KAKOU USA, LLC will provide quality, low cost and effective machining and fabrication services to our customers. With our engineering/maintenance experience, we will ensure that your designs and parts are completed to your specifications. With attention to detail from concept thru production, your project will yield the highest quality.

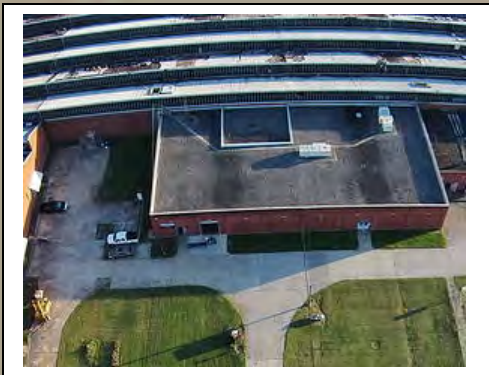

A GROWING COMPANY



KAKOU USA, LLC Main Plant

Address:	4901 Enka Hwy. Morristown, TN 37814
Assembly Area:	262ft x 130ft (80m x 40m)
Machining & Welding Area:	130ft x 130ft (40m x 40m)
Office Area:	60ft x 60ft (20m x 20m)

KAKOU USA, LLC Lexington Office

Address:	2025 Leestown Rd Suite Q Lexington, KY 40511
Assembly Area:	50ft x 55ft (15m x 17m)
Machining & Welding Area:	56ft x 32ft (17m x 10m)
Office Area:	68ft x 64ft (21m x 20m)



KAKOU USA, LLC Atlanta Office

Address:	819 Pickens Industrial Drive Atlanta, GA 30062
Office & Machining Area:	60ft x 27ft (20m x 9m)



THREE BRANCHES READY TO HELP YOU WITH YOUR DESIGN, ASSEMBLY, AND FABRICATION NEEDS!

KAKOU USA, LLC

"COMMITMENT TO EXCELLENCE"

www.kakouusa.com

MORRISTOWN TENNESSEE FACILITY

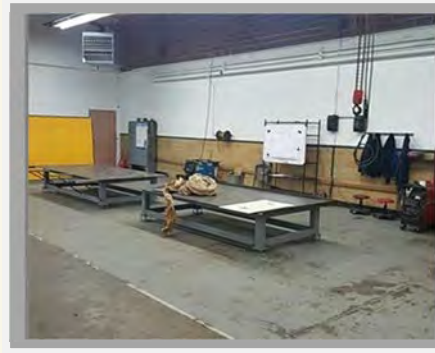

KAKOU USA, LLC

"COMMITMENT TO EXCELLENCE"

www.kakouusa.com

LEXINGTON KENTUCKY FACILITY

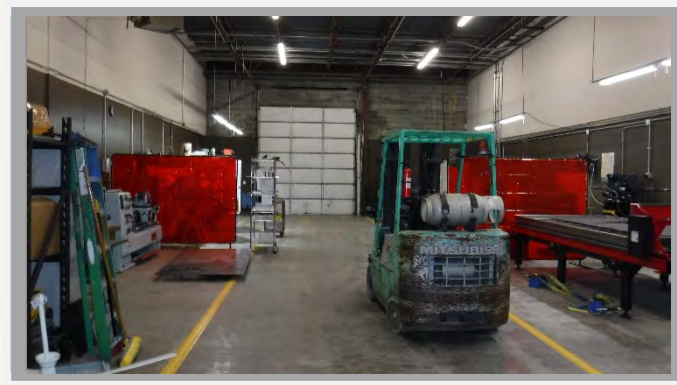
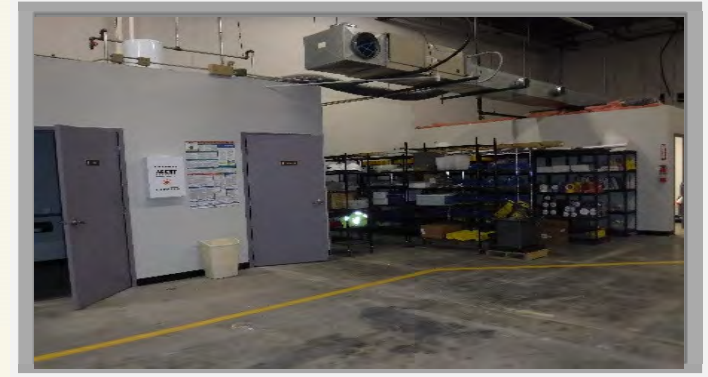
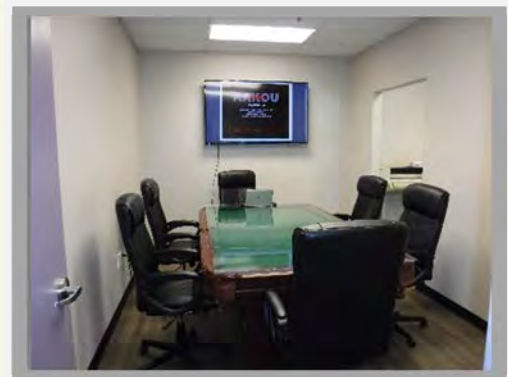
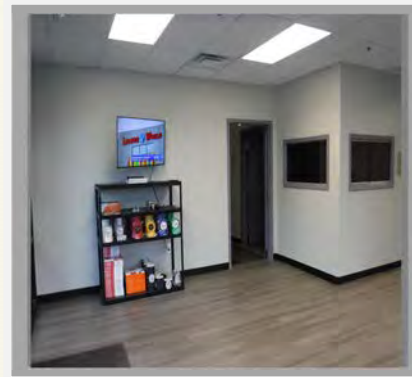
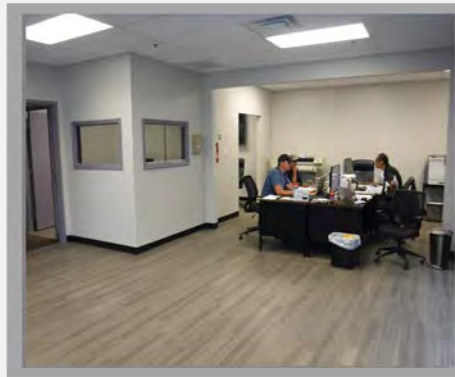

SEAT ASSY CHECKING FIXTURE

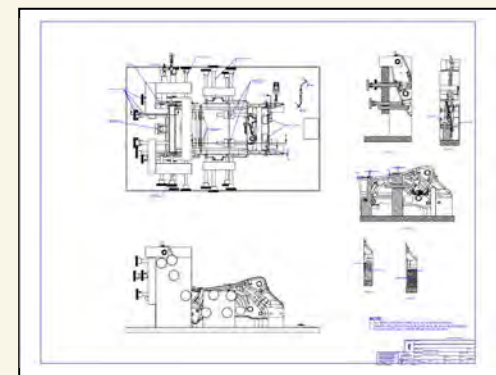
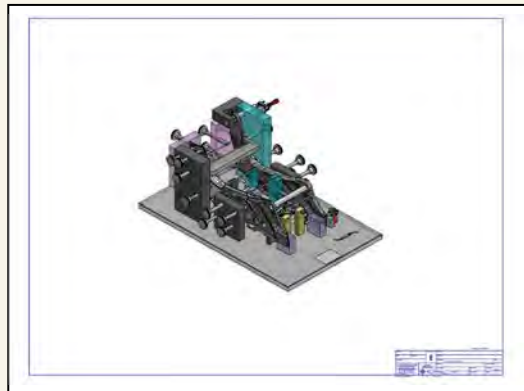

SIDE FRAME CHECKING FIXTURE

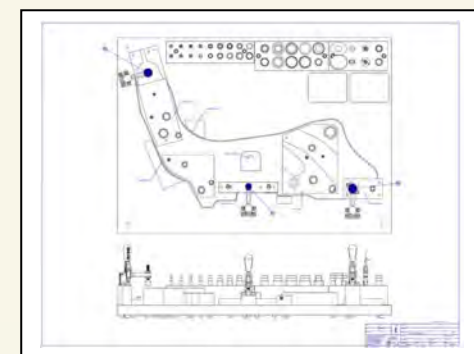
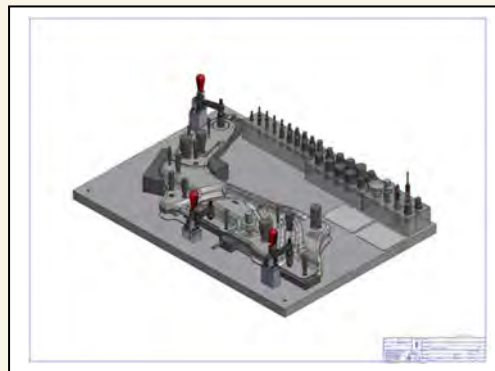
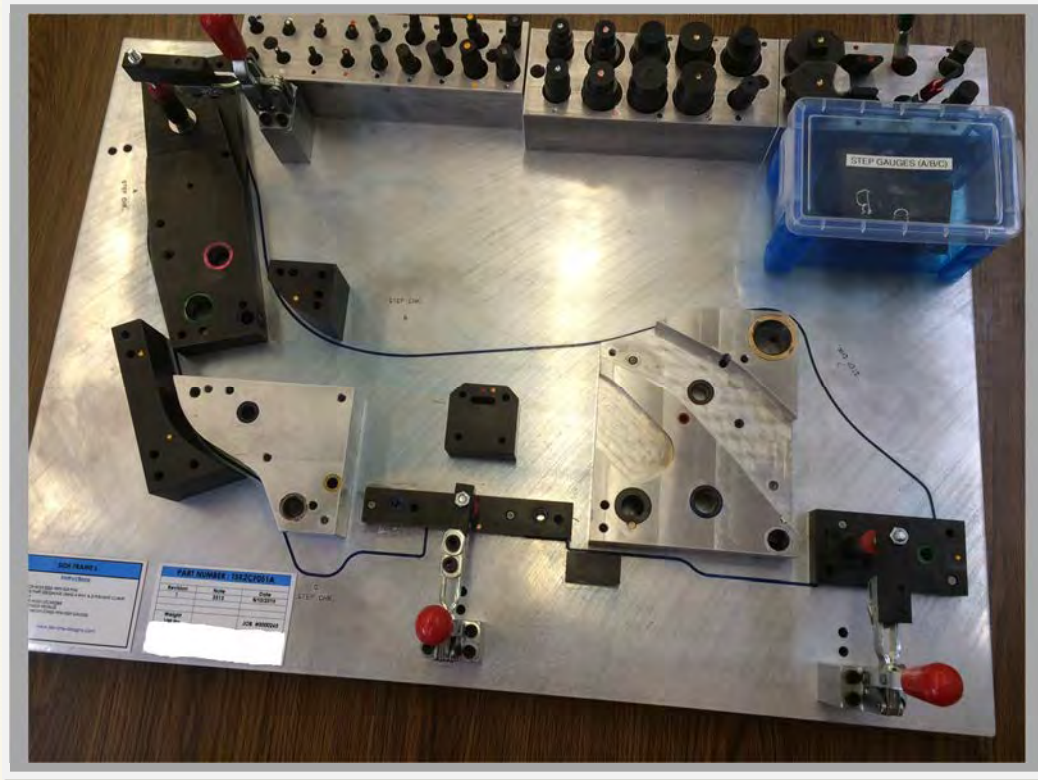

PROGRESS DIE

PROGRESS DIE

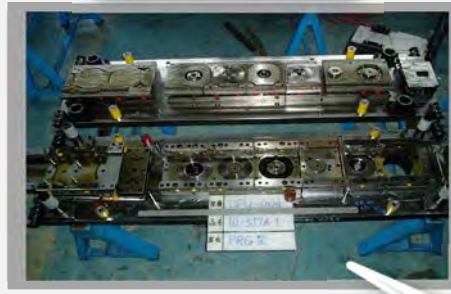

PART



300t PRESS

600t PRESS

300t PRESS

300t PRESS

CHECKING GAUGE



FULLY AUTOMATIC ASSEMBLY LINE



DESIGN
FABRICATE
ASSEMBLY
TRIAL
INSTALLATION

ALL COMPLETED IN HOUSE!

PISTON INSERTION

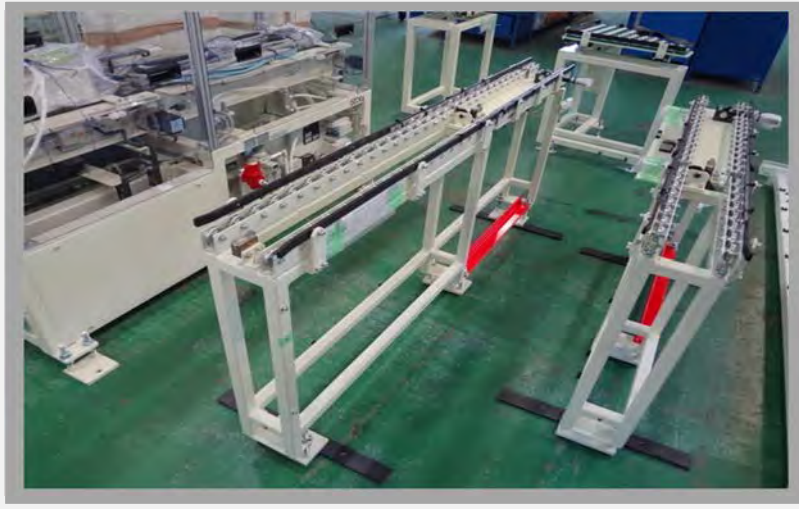

ENGINE BLOCK SHUTTLE SYSTEM

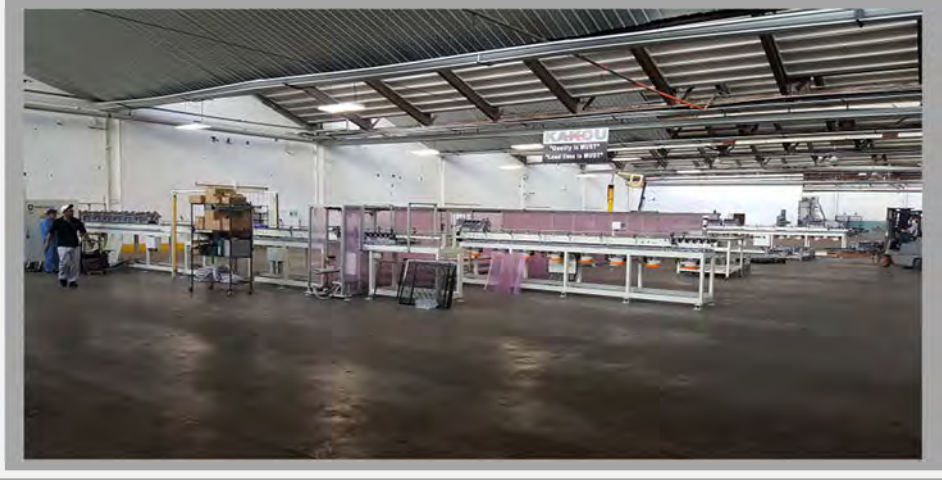

FULLY AUTOMATIC TRANSFER CART SYSTEM

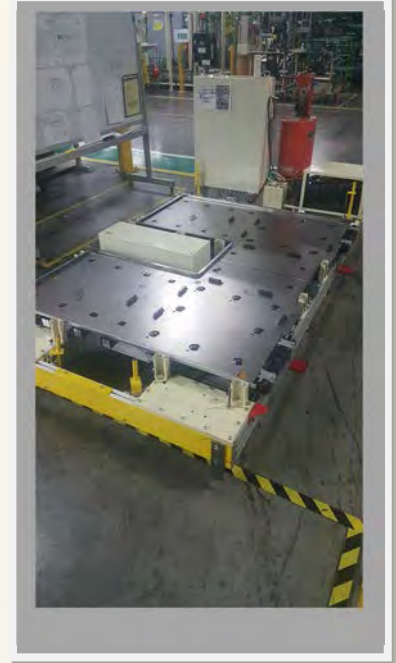

Control Panel

Sub Panel

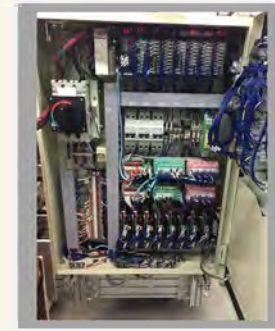

COOLING CONVEYOR SYSTEM



**MIGHTY LINE AUTHORIZED
DISTRIBUTOR**



MIGHTY LINE

The Only Durable Stripe

Patent No. 8,088,480
Patent No. 8,343,292

Mighty Line offers durable safety floor tapes, floor signs, 5s floor markings and other 5s floor tape products for warehouses. At Mighty Line, we wanted to provide customers one of the strongest industrial floor tapes on the market. We know how important safety is to every organization. Our tapes are great for industrial warehouses, hospitals, oil and gas facilities, factories, and other floor marking areas. With a peel and stick adhesive that removes cleanly upon removal, Mighty Line couldn't be easier to use!

What Makes Mighty Line Floor Tape Different?

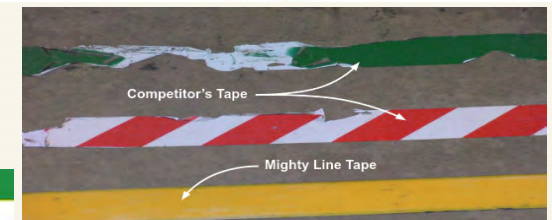
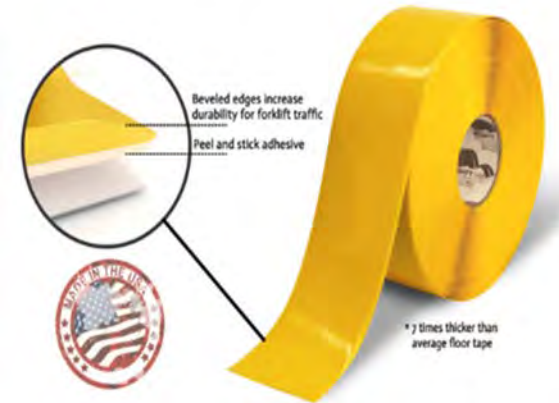

Mighty Line Hazard diagonal tape

Our hazard diagonal floor tape is the most durable on the market and the colors will not fade with the every day heavy duty industrial use



Mighty Line Reflective Dock Door Tape!
Makes it Easier to back up to a dock AT NIGHT!

Reflective Dock Door Tape at DAYTIME Reflective Dock Door Tape at NIGHTTIME

ShieldMark Inc. • www.mightylinetape.com • 800-714-9980

COMPETITOR COMPARISON: 9 MONTHS LATER



**CUSTOM SIGNS AVAILABLE!
CALL TODAY!**

CONTACT US TO ORDER!

REQUEST A FULL
CATALOG OR ASK FOR A
QUOTE TODAY!
WWW.KAKOUUSA.COM

**T-SLOTS AUTHORIZED
DISTRIBUTOR**



FUTURA INDUSTRIES have the most consistent quality and widest range of offerings for your TSLOT needs because we manufacture and distribute our T-Slotted aluminum extrusions on site in the USA. FUTURA INDUSTRIES work with your designs and offer free software options and concept assistance to help you make your plans a reality. FUTURA INDUSTRIES also offer customization for color and anodized finishes, so you will never have to paint your products unless you want to.



**Yellow Aluminum
Extrusions for
Safety!!!**

Our products are lightweight, durable and prefinished in any color you need. When you use our custom brackets, fasteners, hinges and hardware, our aluminum extrusion TSLOTS are easy to assemble – all you need is a few hand tools. Once you have built your product to your custom specifications, your high-strength structure will never need maintenance.

CONTACT US TO ORDER!

**GO TO
WWW.KAKOUUSA.COM
TO REQUEST A FREE
CATALOG TODAY!**



Machine Fixture



Enclosure (safety)



Automation



**PRESTO ECOA
AUTHORIZED DISTRIBUTOR**



For over 70 years, Presto Lifts, Inc. has been creating precision hydraulic equipment that improves safety and productivity. Presto Lifts offers more than 500 different models of lifts, tables and tilters -- more than any other company in the world. In 2016 Presto Lifts acquired ECOA Industrial Products. ECOA's products have allowed us to expand into the production of bigger footprint, heavier capacity, and custom designed equipment required throughout many of the same facilities that currently use Presto products. All of our products are put through a rigorous 110% testing before shipment, to ensure our high quality standards are met. If service is required, all standard replacement parts are carried in stock and are shipped within 24 to 48 hours.

CUSTOM LIFTS AVAILABLE!

Presto ECOA manufactures standard ergonomic lifting equipment with capacities ranging from 500lbs-120,000 lbs, as well as providing for all of your customized needs. Our talented team of engineers and designers will work with you to provide exactly what you need, delivered on time and competitively priced.

(AIS) ALWAYS-IN-STOCK PROGRAM

The Presto Always-in-Stock (AIS) Program is a key factor in our ability to satisfy customer requirements more quickly than other suppliers. New inventory systems and state-of-the-art manufacturing processes ensure that our most popular products are Always-in-Stock and available for immediate shipment - **1 week or less**

CONTACT US TO ORDER!

**REQUEST MORE
INFORMATION AT
WWW.KAKOUUSA.COM**



**SWISS PRECISION
INSTRUMENTS
AUTHORIZED DISTRIBUTOR**



For over 50 years, Swiss Precision Instruments, Inc. has continuously introduced exciting new products to the metalworking industry. Since 1956 the SPI family of products has always offered customers Quality, Value and fast Delivery. Today the tradition continues.

Our 432 page catalog features all of the SPI Branded Products. You will find numerous New, Unique and Hard to Find Measuring Tools, Optical Tools, Machine Tool and Shop Accessories.

The SPI Brand of Products is sold, exclusively, through a network of more than 1,000 dealers throughout the United States as well as 26 foreign countries.



CONTACT US TO ORDER!

**GO TO
WWW.KAKOUUSA.COM
TO REQUEST A FREE
CATALOG TODAY!**

TECHNO RISE
AUTHORIZED DISTRIBUTOR

KAKOU USA is the only Distributor of Techno Rise products in the United States!

CMP MACHINE



High Precision Single-sided Lapping & Polishing Machine



Automatic Fixed-sizing Single-sided Lapping System



Double-sided Lapping & Polishing Machine



More highly functional and top quality products are demanded by every industry. The Techno Rise motto and goal since the founding of our company is

"to provide the accuracy that is beyond the standard".

We have promoted engineering developments in various devices and have provided products with top reliability. Our products, such as lapping/polishing related tools, semiconductor related equipment, flat/spherical surface grinding machines, different kinds of jigs, silicon wafers, environmental products, as well as optical communication devices have been highly evaluated and praised by our customers.

Techno Rise continuously introduces better products to contribute to our society.



Super high-precision

The aim of Techno Rise is to provide the technology that can set the new trend of the modern era to open the way to our user's future.

KAKOU

USA

KAKOU USA, LLC

Address: 4901 Enka Hwy. Morristown TN 37814

Phone: (423) 585-7382

Web: www.KAKOUUSA.com

(Machining. Fabrication. Equipment build)

“COMMITMENT TO EXCELLENCE”

FOLLOW US ON: 